

Western Orthopaedic Association (WOA)

Exhibitor Service Kit | Discount Price Deadline Date: ****Tuesday, July 16, 2019****



1600 33rd Street, Unit 102
Orlando, Florida 32839
T. 407.872.2223 F. 407.872.8644
Email: info@gobencs.com

Exhibitor Service

Manual

WOA

July 31 – August 3, 2019

The Hyatt Regency, Monterey, CA



1600 33rd Street, Unit 102
Orlando, Florida 32839
T. 407.872.2223 F. 407.872.8644
Email: info@gobencs.com

Exhibitor Manual Contents

Page	Content
1	Show Cover Page
2	Manual Contents
3	Online Ordering Info
4	Exhibitor Compass - Information
5	Service Contractor Info & Contacts
6	General Information
7	Payment Terms & Conditions
8	Billing Authorization
9	EAC (Exhibitor Appointed Contractor)
10	Furniture & Accessories
11	Credenza/Computer Kiosks
12	Custom Rental Units
13	Price List- Credenza/Computer Kiosk/Custom Units
14	Carpet & Padding
15	Cleaning Services
16	Signs & Graphics
17	Floral Pictures
18	Floral Order Form
19	Audio
20	Labor & Forklift Services
21	Material Handling Information
22	Material Handling Information (Continued)
23	Material Handling Service & Rates
24	Exhibitor Shipping Information
25	Advance Warehouse Shipping Label
26	Show Site Delivery Shipping Label
27	Move Out Information
28-29	UPS Freight Flyer & CC Form
30	PSAV Electrical and Internet



Official Exhibitor Services Supplier for WOA

You can log in if you prefer to order online!

How do I log in?

Once your show is available online, you will receive an automated email that includes your personalized show code. All information within the email will allow you to retrieve show documents, order online, and submit changes to your order.

If you do not receive a show code and wish to order online, please contact us at (407) 872-2223 or email orders@gobencs.com

Please be aware that you will need to create a new account when you place your first order. Don't worry - it's quick and easy and will help us serve you better.

Please note Goblen CS Fees/Charges:

Goben Convention Services assesses fees for changes and cancellation of your show order. Please review the following.

* After orders are submitted online, you will have up to 24 hours to add/remove items from your order without penalty. After order processes, a 5% administrative fee is charged for all changes/refunds.

* Due to preparations and equipment readiness, orders that are cancelled 1 week before the move - in date are assessed a 50% cancellation fee.

* For orders cancelled on day of move - in or after delivery to booth, cancellation fee is 100%.

Questions?

Contact Customer Service at (407) 872-2223 or email orders@gobencs.com

Western Orthopaedic Association (WOA)

Exhibitor Service Kit | **Discount Price Deadline Date: **Tuesday, July 16, 2019****



1600 33rd Street, Unit 102
Orlando, Florida 32839
T. 407.872.2223 F. 407.872.8644
Email: info@gobencs.com

Exhibitor Compass

EXHIBIT MOVE IN		
Day	Date	Time
Wednesday	July 31, 2019	12noon – 5pm

EXHIBITOR HOURS		
Day	Date	Time
Thursday	August 1, 2019	6:15am – 1pm
Friday	August 2, 2019	6:15am – 1pm 5:30pm – 7:30pm <i>Reception</i>
Saturday	August 3, 2019	6:15am – 11am

EXHIBIT MOVE OUT		
Day	Date	Time
Saturday	August 3, 2019	11am

DISMANTLE | CARRIER CHECK-IN

To ensure that all exhibitor materials are removed from the exhibit facility by the exhibitor move-out deadline, please have your carriers check in by:

Day	Date	Time
Saturday	August 3, 2019	12:30pm

RE-ROUTE TIME

If your carrier has not checked in your freight will be re-routed with the show carrier at:

Day	Date	Time
Saturday	August 3, 2019	12:31pm

DISMANTLE | MOVE OUT DEADLINE

All exhibitor materials must be removed from the exhibit facility by:

Day	Date	Time
Saturday	August 3, 2019	1pm

See Carrier Check-in time above to ensure that you plan according to the dismantle/move out deadline.

IMPORTANT INFORMATION

Schedules listed above are subject to change by show management. Should any freight/materials be left at the exhibit venue after the Dismantle & Move Out Deadline, Goblen Convention Services reserves the right to re-route all freight/materials via the preferred carrier of Goblen Convention Services. Any and all shipping and handling charges by the preferred carrier of Goblen Convention Services will be billed and paid by the exhibitor. Goblen Convention Services is not responsible for those shipping charges for freight/materials left after the Move Out Deadline.

BOOTH INFORMATION	
Standard Booth Size – 8’ deep x 10’ wide - Pipe & Drape –	

Back Wall	Blue & White
Side walls	Blue
Table Skirt	Show Colors

Included Booth Package Equipment	Quantity
6’x30” skirted table in show colors	1
booth identification sign	1
Wastebasket with Liner*	1
Padded Chairs	2
The Regency Ballroom is carpeted – multi color	

There are no substitutions with included booth package equipment Your preferred alternatives may be ordered through the exhibitor manual.

*Wastebasket with liner does not include emptying of trash or booth vacuuming. Cleaning services if required must be ordered through the exhibitor manual.

IMPORTANT DATES	
	Mark your Calendar
Shipments can start arriving at Advance Warehouse	June 24, 2019
Discount deadline orders received with confirmed payment.	July 16, 2019
In Observance of Independence Day	July 4 - 5, 2019 Closed all day
Last Day for Shipment to arrive at warehouse w/o surcharge	July 19, 2019
Last day for shipments to arrive at warehouse	July 26, 2019 STRICTLY ENFORCED
Shipments can start arriving at Show Site	July 31, 2019 STRICTLY ENFORCED
Move Out	August 3, 2019
Driver check in for move out	12:30pm
Re-Route freight	12:31pm

VENUE INFORMATION

The Hyatt Regency
c/o Goblen CS
1 Old Golf Course Rd
Monterey, CA 93940



1600 33rd Street, Unit 102
Orlando, Florida 32839
T. 407.872.2223 F. 407.872.8644
Email: info@gobencs.com

Service contractor information & contacts

QUICK CONTACTS

REGISTRATION – BOOTH ASSIGNMENT

Liza Connor | Data Trace
T. 410-494-4994
Email: lconnor@datatrace.com

SHIPPING – STORAGE – FURNITURE - PLANTS SIGNS – LABOR – CARPET – CLEANING

Stephanie Placeres | Goben Convention Services
T. 407-872-2223 | F. 407-872-8644
Email: stephanie@gobencs.com

CUSTOM FURNITURE

Stephanie Placeres | Goben Convention Services
T. 407-872-2223 | F. 407-872-8644
Email: stephanie@gobencs.com

AUDIO VISUAL

Myra Murray | Goben Convention Services
T. 407-872-2223 | F. 407-872-8644
Email: myra@gobencs.com

ELECTRICAL / INTERNET

PSAV
T. 831-657-6694
Email: pbench@psav.com

UPS Freight

Preferred Show Carrier
Customer Service Trade Show Dept.
T. 800-988-9889

SHIPPING INFORMATION

ADVANCE WAREHOUSE ADDRESS

Shipping Address & Preferred Label Format

****Exhibiting Company Name****

****Exhibiting Booth #****

WOA

Show Ready c/o

Goben Convention Services

224 Mercury Circle

Pomona, CA 91768

Warehouse materials are accepted at the warehouse

Monday – Friday | 8:30am – 4:00pm

Goben Convention Services will start accepting crates, boxes
and skidded materials beginning:

June 24, 2019

Starting at 8:30am

**In Observance of Independence Day,
the warehouse hours will be as follows:
Thursday, July 4th & Friday, July 5th – Closed All Day**

SHOW SITE ADDRESS

Shipping Address & Preferred Label Format

****Exhibiting Company Name****

****Exhibiting Booth #****

WOA

C/O Goben Convention Services

The Hyatt Regency

1 Old Golf Course Rd

Monterey, CA 93940

Shipments arriving before this date and time may be refused
by the facility. Any charges incurred for early freight
accepted by the facility are the responsibility of the
exhibitor.

Goben Convention Services will start accepting crates, boxes
and skidded materials beginning:

Wednesday, July 31, 2019

Starting at 8am

STRICTLY ENFORCED!

*PLEASE DO NOT SEND FREIGHT TO THE HOTEL PRIOR TO JULY 31st.
IF YOUR FREIGHT ARRIVES BEFORE THIS DATE THERE IS A CHANCE
IT MAY BE REFUSED. THE HOTEL DOES NOT HAVE THE STORAGE OR
MANPOWER TO HANDLE TRADE SHOW FREIGHT. IF THE HOTEL
DOES ACCEPT YOUR FREIGHT THEN YOU WILL BE CHARGED A
HANDLING FEE BY THE HOTEL AND THEN BY GOBEN CS.
PLEASE SEE "MATERIAL HANDLING" ON NEXT PAGE.*

General Information



1600 33rd Street, Unit 102
Orlando, Florida 32839
T. 407.872.2223 F. 407.872.8644
Email: info@gobencs.com

Material Handling

Goben Convention Services has been contracted to handle this event which includes all drayage whether it is received at the warehouse or the show site. As the **"EXCLUSIVE"** material handling contractor we will handle **ALL** freight shipments in and out of the ballroom.

Warehouse receiving hours are 8:30am – 4:00pm, Monday – Friday.
You may start sending freight to the advance warehouse 30 days prior to the start of show at no additional charge.

Drayage is defined as the delivery of freight from the advanced warehouse, loading dock or hotel storage room to your booth space and from the booth space to the loading dock at the close of the show.

Please note if you send freight to the show venue before the published date listed in this exhibitor manual your freight will either be **REFUSED** or you will be charged handling & storage fees from the hotel. The freight will then be turned over to Goben CS for delivery to the exhibit hall and you will **ALSO** be charged material handling fees, **even if you are a guest of the hotel.**

Please note: Mislabeled packages have the potential of being refused at show site. Please remember to include WOA c/o Goben CS on all packages AND remove all old labels from packaging.

Preferred Freight Carrier

Listed below is the information for the official freight carrier of Goben Convention Services.



800.988.9889

www.UPSFreight.com

UPS FORM LOCATED AT THE BACK OF THIS MANUAL
MENTION SHOW NAME FOR DISCOUNTED SHOW RATES

International Shipments

Should your display require clearance by a United States Customs Office you must make arrangements with a custom broker. Goben Convention Services cannot clear the shipment on behalf of the shipper.

Equipment Use

Goben Convention Services does not lend out any equipment to exhibitors. If you require help for the setup of your booth, you must fill out the provided labor forms included in this service kit. Please note that request for labor services on show-site is not guaranteed. If you require assistance bringing items to your booth, please note that you are subject to material handling fees and labor charges at the current prevailing cost.

Labor

Labor is for installation & dismantling of displays, Please refer to the Labor forms included in this manual to order services. TIP: Order early and in advance to guarantee labor services. Exhibitors may setup and dismantle their own displays provided they use their own company employees to do so.

Exhibitor Appointed Contractors

If you are utilizing an outside contractor, Goben Convention Services must be informed two weeks prior to setup. A valid "certificate of insurance" must be submitted to Goben Convention Services by the date illustrated on the Exhibitor Appointed Contractor Notification form included in the exhibitor service kit. Notifications received after the date may not receive approval. Failure to provide Goben Convention Services a certificate of insurance will result in labor hire from the Goben Convention Services staff. The non-official contractor will be able to provide supervision only. Exhibitor Appointed Contractors who subcontract for services other than general contracting are also considered non-official contractors and must follow set procedures; this includes florists, audio visual and computer rental firms.

Security

Exhibitors are responsible for safeguarding their goods, materials, equipment and exhibits at all times. Goben Convention Services is not responsible for any unattended items left in the tradeshow facility or assigned booths.

Safety

Standing on chairs, tables or any rental furnishings is prohibited. Goben Convention Services is not responsible for injuries or falls caused by improper use of furnishings. Should a folding chair not accommodate you, please advise us and we will substitute that chair with a current in-stock side chair upon availability.

If assistance is required in the installation/dismantle of your booth, please order labor using the enclosed labor form and the necessary ladders, and tools that need to be provided.

Acceptance of General Information

By signing off on any services/order provided by Goben Convention Services automatically indicates that you, the client/exhibitor, are in acceptance and agreement of our general information section. Any questions about the general information section for Goben Convention Services, please contact us at 407-872-2223 or at info@gobencs.com.



1600 33rd Street, Unit 102
Orlando, Florida 32839
T. 407.872.2223 F. 407.872.8644
Email: info@gobencs.com

Payment terms & conditions

Payments

Goben CS requires that you provide a credit Card Authorization with your initial order. For your convenience we will use this authorization to charge your account for services, which may not have been covered by your initial order. Purchase Orders are not considered payment.

All orders received without the method of payment form will be charged standard rates.

For the convenience of all, we ask that all disputes be questioned prior to show close via calling the office or visiting the on-site service desk for billing questions and concerns. If an exhibitor fails to pay their invoice prior to close of show, the charges will automatically be applied to the credit card on file.

Method of Payment

We accept Master card, Visa, American Express & checks (US Bank)

Fees

A \$30.00 charge will apply for charges associated with the following:

~ *Insufficient Funds*

~ *Charge back fees on credit cards*

This fee will be added to your final invoice.

Wire Transfers

If you are using wire-transfers for payment, please add an additional amount of \$55.00 to the wired amount. This \$55.00 is a processing fee for the wire transfer assessed by Goben Convention Services. Please contact 407.872.2223 for wire transfer information.

International Exhibitors

We require 100% payment of advance and standard orders. Any orders or services placed with Goben Convention Services on show site, those services must be paid in full. Payment must be made via check in United States fund drawn from a United States Bank.

Should your display require clearance by a United States Customs Office you must make arrangements with a custom broker. Goben Convention Services cannot clear the shipment on behalf of the shipper.

Cancellations

Orders cancelled after the discount deadline date will be charged 50% cancellation charge.

Orders cancelled after decorator move-in begins are subject to a 100% cancellation charge.

A one-hour "per person" charge will be applied for all labor orders that are not cancelled in writing at least 24 hours prior to the scheduled start time.

Miscellaneous

Rental Items not ordered but found in the booth space will be invoiced at "standard" rates.

Tax Exemption Status

If you claim tax exempt status, you must provide us with a copy of your tax Exempt Certificate issued by a federal government or state in which the event is taking place, simultaneously with the placement of your initial order, otherwise tax will appear on your invoice.

No credits for sales taxes will be issued after billing is complete.

Tax Rate

All rental items are subject to applicable taxes.

Tax rate for Monterey, CA is 8.75%

Third Party Billing

Each exhibiting firm is ultimately responsible for all charges incurred on its behalf. Goben Convention Services reserves the right to institute a collection action against the exhibitor if the third party does not pay.

Credits

It is the responsibility of the exhibitor/client to check the accuracy of your invoices and report any concerns of your ordered services prior to show close. All concerns reported prior to show close will be considered for credits to your account with Goben Convention Services.

Rentals

All materials and equipment are on a rental basis for the duration of the show and remain the property of Goben Convention Services. All rentals include delivery, installation and removal from your booth.

Unpaid Balances

Should there be any unpaid balance after the close of show; terms will be net, due and payable upon receipt of invoice. Effective 30 days after invoice date, any unpaid balance will bear a finance charge at the lesser of the maximum rate allowed by applicable law, or 1.5% per month, which is an annual percentage rate of 18% and future orders will be on a pre-payment basis. If the finance charge hereunder exceeds the maximum rate allowed by applicable law, the finance charge shall automatically be reduced to the maximum rate allowed, and excess finance charge received by Goben Convention Services shall be either applied to reduce the principal unpaid balance or refunded to the payer. Payment terms and conditions shall be governed and construed in accordance with the laws of the state of Florida.

Acceptance of Payment Terms & Conditions

By signing off on any services/order provided by Goben Convention Services automatically indicates that you, the client/exhibitor, are in acceptance and agreement of our Payment Terms and Conditions. Any questions about the Payment Terms and Conditions for Goben Convention Services, please contact us at 407.872.2223 or at info@gobencs.com.

Western Orthopaedic Association (WOA)Exhibitor Service Kit | **Discount Price Deadline Date: **Tuesday, July 16, 2019****

1600 33rd Street, Unit 102
 Orlando, Florida 32839
 T. 407.872.2223 F. 407.872.8644
 Email: orders@gobencs.com

Billing Authorization

EXHIBITING COMPANY INFORMATION			
Exhibiting Company Name:			
Booth#			
Exhibiting Company Address:			
City/State/Zip:			
Phone :		Fax:	
E-mail:			

Payment Options	
	Select One
<input type="checkbox"/>	Credit Card
<input type="checkbox"/>	Company Check
<input type="checkbox"/>	Cash
<input type="checkbox"/>	Wire Transfers (call for details)

Goben Convention Services gladly accepts Cash, Company Check, Credit Card and Wire Transfers.

Billing Address (If different from above)	
Address:	
City/State/Zip:	
Phone:	
Fax:	
E-mail:	

EXHIBITOR CREDIT CARD AUTHORIZATION

For your convenience, we will use this credit card billing authorization to charge your credit card account for your advance, standard and on-site orders, along with any additional amounts incurred as a result of show site orders placed by your exhibit booth representative.

VISA

 MASTERCARD

 AMERICAN EXPRESS

Card Holder Name:			
Credit Card Number:		Expiration Date:	
Goben Convention Services is committed to keeping your provided financial information safe and secure		Validation Code: <small>(3 or 4 Digit Code on the back or bottom of the Credit Card)</small>	
Printed Name:			
Signature:		Date:	

By signing, you acknowledge you have read, understand and agree to all the terms in the payment terms and conditions and have advised our organization of any questions on purchases of services and materials. You also acknowledge and have read, understand and agree to the general information sections of the exhibitor manual. The payment terms & conditions and general information are included in this exhibitor manual.

Third Party Billing

Please call the office at 407-872-2223 for a third party billing authorization form



1600 33rd Street, Unit 102
 Orlando, Florida 32839
 T. 407.872.2223 F. 407.872.8644
 Email: orders@gobencs.com

EAC - exhibitor appointed contractor

In the event you are planning to utilize a firm other than GOBEN CONVENTION SERVICES, the Exhibitor must complete and acknowledge the requirements and procedures to have an Exhibitor Appointed Contractor/EAC on-site.

This notification must be turned in with Certificate of insurance by the date of:

July 16, 2019

EXHIBITING COMPANY INFORMATION ~ Please print clearly ~	
Exhibiting Company:	
Booth #:	
Contact Telephone:	
Exhibitor Contact Name:	
Exhibiting Firm's Officers Signature:	

EXHIBITOR APPOINTED CONTRACTOR / EAC "Non-Official Contractor" ~ Please print clearly ~	
Contractor Company Name:	
Contact Telephone:	
Contact E-mail:	

With this form a CERTIFICATE OF INSURANCE showing General Liability and Workman's Compensation valid in the state where the show is being held, naming GOBEN CONVENTION SERVICES, as an additional insured and certificate holder. The CERTIFICATE OF INSURANCE MUST be submitted together with this notification. We will not accept a CERTIFICATE OF INSURANCE on-site on the show floor. This is due by the date listed above, on the top of this page.

The exposition floor, aisles, loading docks, services and storage areas will be under the control of Goben Convention Services. The Exhibitor Appointed Contractor (EAC) / Non-Official Contractor must coordinate all of its activities with Goben Convention Services.

The Exhibitor Appointed Contractor (EAC) / Non-Official Contractor will be responsible for all reasonable costs related to its operation, including overtime pay for stewards, restoration of exhibit space to its initial condition, freight handling charges, etc. It will be the responsibility of the Exhibitor Appointed Contractor (EAC) / Non-Official Contractor to remove from the floor all tape installed, any bulk trash from the booth floor and from the exhibit hall (such as skids or crates) will be invoiced accordingly by Goben Convention Services.

These requirements will be strictly enforced. In the event that these rules are not adhered to, labor must be hired through Goben Convention Services.

This form along with your Certificate of Insurance can be submitted via these options:

FAX	MAIL	E-MAIL
407.872.8644	Goben Convention Services 1600 33 rd Street, Unit 102 Orlando, Florida 32839	orders@gobencs.com



1600 33rd Street, Unit 102
 Orlando, Florida 32839
 T. 407.872.2223 F 407.872.8644
 Email: orders@gobencs.com

Furniture & Accessories

Exhibiting Company:	
Booth:	

SEATING				
Qty	Description	Discount	Standard	Total
	Side Chair	40.00	50.00	
	Padded Folding Chair	40.00	50.00	
	Upholstered Arm Chair	50.00	62.00	
	Upholstered Counter Stool	54.00	67.00	
	Secretary chairs	50.00	62.00	
	Herman Millar Aeron Posture Fit	300.00	375.00	

ACCESSORIES				
Qty	Description	Discount	Standard	Total
	Chrome Stanchion	28.00	35.00	
	Velvet Rope (gray/red)	15.00	19.00	
	Wastebasket	12.00	15.00	
	Sign Holder 22"x28"	42.00	53.00	
	Chrome Tripod Easel	28.00	35.00	
	Literature Rack	100.00	120.00	
	Bag Rack	37.00	46.00	
	Fish Bowl	15.00	19.00	
	Raffle Drum	85.00	106.00	
	Refrigerator 34"	125.00	156.00	
	Filing Cabinet (lockable) 28"	70.00	87.00	
	Glass Display Case	Call for Pricing		
	Podium	Call for Pricing		
	Grid Wall 2'x8' sections	80.00	100.00	
	Poster Board 4'x6'	97.00	122.00	
	Poster Board 4'x8'	115.00	144.00	

SPECIAL BOOTH DRAPE				
Qty	Description	Discount	Standard	Total
	White Vinyl Table Cover	12.00	15.00	
	Table Skirt 30"	55.00	69.00	
	Table Skirt 42"	60.00	75.00	
	8' Masking Drape	10.00/lf	12.00/lf	
	3' Masking Drape	7.00/lf	9.00/lf	
	8' Upright	9.00	11.00	
	3' Upright	9.00	11.00	
	Cross Beam	9.00	11.00	

When ordering, please select color below

Black	Blue	Burgundy	Gold	Peach
Gray	Red	Teal	White	Mauve

TABLE TOP RISERS				
Qty	Description	Discount	Standard	Total
	4' Single Step 12' High	25.00	31.00	
	6' Single Step 12' High	35.00	44.00	
	8' Single Step 12' High	45.00	56.00	

TABLES				
24" Draped Table				
w/white plastic top and draped on 3 sides				
Qty	Description	Discount	Standard	Total
	4' long 30" high	80.00	100.00	
	4' long 42" high	95.00	119.00	
	6' long 30" high	95.00	119.00	
	6' long 42" high	110.00	137.00	
	8' long 30" high	110.00	137.00	
	8' long 42" high	125.00	156.00	
	To have the 4 th side draped	27.00	34.00	

When ordering, please select a color below

Black	Blue	Burgundy	Gold	Peach
Gray	Red	Teal	White	Mauve

24" Undraped Table				
w/white plastic top				
Qty	Description	Discount	Standard	Total
	4' long 30" high	45.00	56.00	
	4' long 42" high	60.00	75.00	
	6' long 30" high	60.00	75.00	
	6' long 42" high	75.00	94.00	
	8' long 30" high	75.00	94.00	
	8' long 42" high	90.00	113.00	

ROUND COCKTAIL TABLES				
(Tables are laminated and do not come with a table skirt. Spandex coverings are available at an additional charge. See Spandex Cocktail Cover Below)				
Qty	Description	Discount	Standard	Total
	24" Diameter 30" High	65.00	81.00	
	24" Diameter 42" High	70.00	87.00	
	30" Diameter 30" High	80.00	100.00	
	30" Diameter 42" High	85.00	106.00	
	36" Diameter 30" High	95.00	119.00	
	36" Diameter 42" High	100.00	125.00	

SPANDEX COCKTAIL COVER				
Qty	Description	Discount	Standard	Total
	Spandex Cocktail Cover	\$59.00	\$74.00	

Black	White	Silver	Navy	Red
-------	-------	--------	------	-----

CUSTOM BAR STOOLS & COCKTAIL TABLE				
Qty	Description	Discount	Standard	Total
	Bar stool (Black)	\$145.00	\$181.00	
	Bar stool (White)	\$145.00	\$181.00	
	Cocktail table (Black)	\$155.00	\$193.00	
	Cocktail table (White)	\$155.00	\$193.00	

- Martini Bar available upon request.

Charges listed include delivery to your booth and removal at the close of show. If you are looking for furnishings that are not listed please contact Goben CS for request. All ordered furnishings and accessories are rentals, not sales as they must be returned at the end of show.

THIS FORM MUST BE ACCOMPANIED BY:
 CREDIT CARD BILLING CARD AUTHORIZATION or the
 THIRD PARTY CREDIT CARD BILLING FORM. ORDERS
 WITHOUT PAYMENT CANNOT BE PROCESSED.

Furnishings Subtotal:	
Sales Tax: 8.75%	
Furnishings Total:	



1600 33rd Street, Unit 102
Orlando, Florida 32839
T. 407.872.2223 F. 407.872.8644
Email: orders@gobencs.com

Credenza/Computer

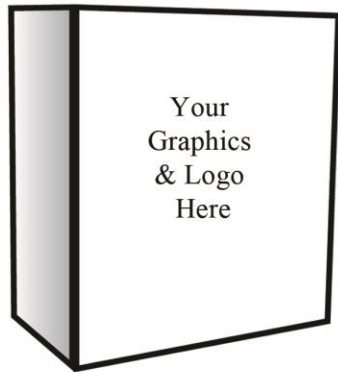

Credenza - Option 1A (1 Meter)
Option 1B (2 Meter)

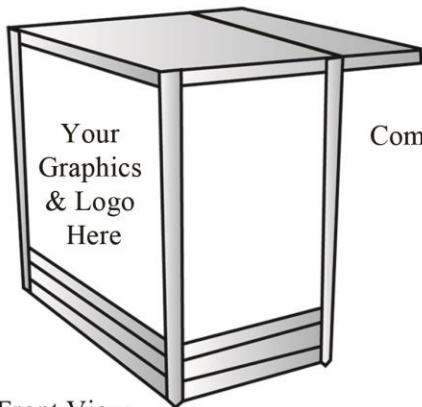
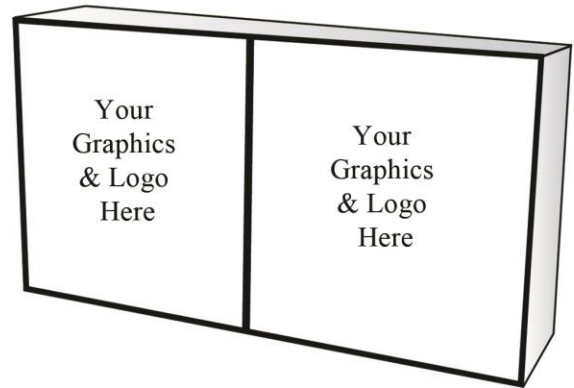

Computer Kiosk - Option 2

Front View

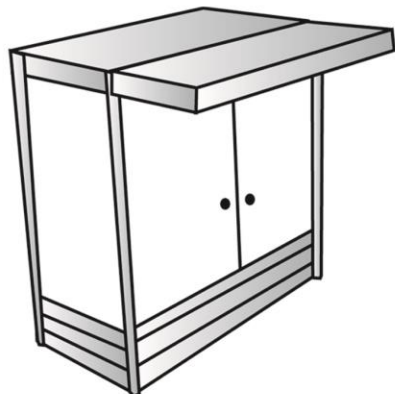

Back View

Internet Café - Option 3A (Single sided)
Option 3B (Double sided)

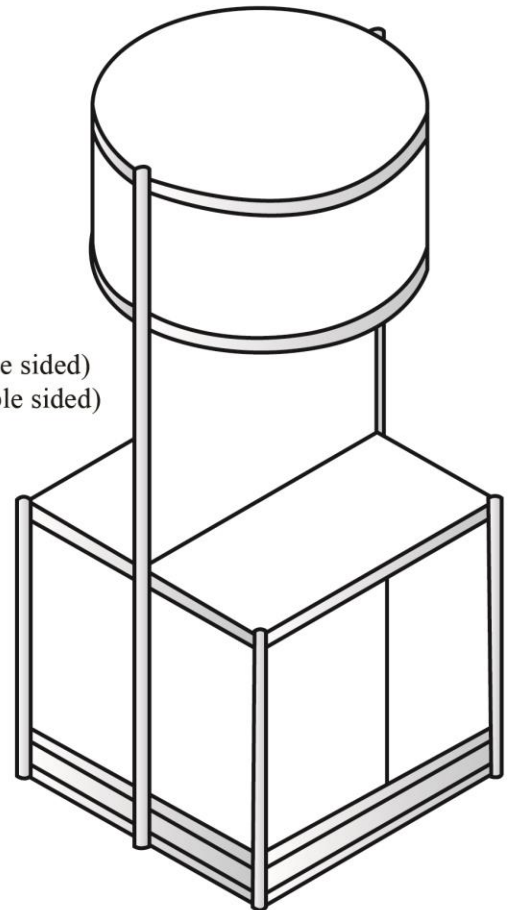



1600 33rd Street, Unit 102
Orlando, Florida 32839
T. 407.872.2223 F.
407.872.8644
Email: orders@gobencs.com

Custom Rental Units

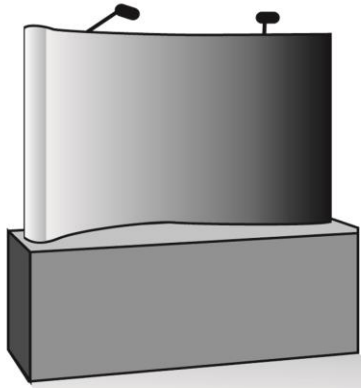
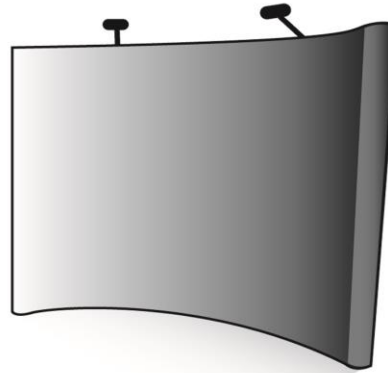

Table Top Display - Option 4



8' Popup Display - Option 5

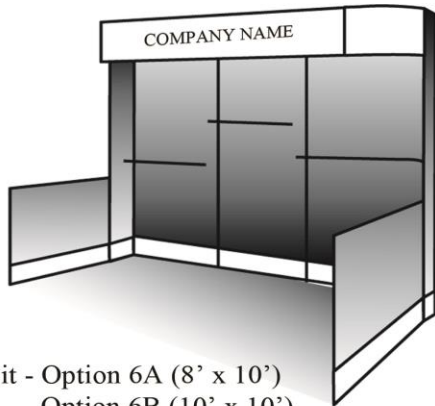

Exhibit - Option 6A (8' x 10')
Option 6B (10' x 10')

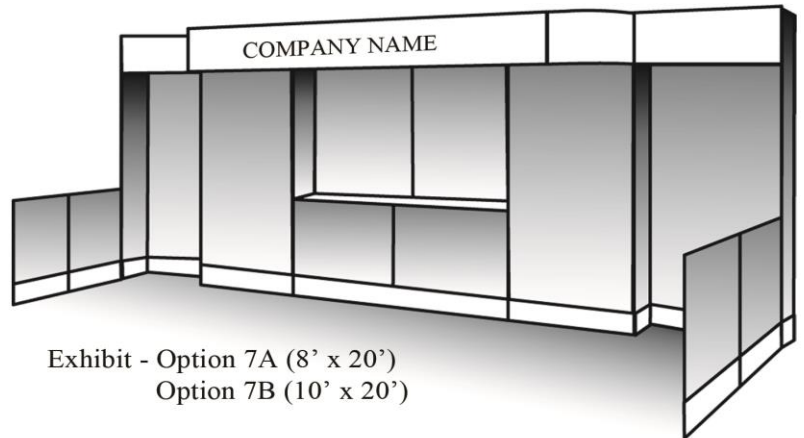
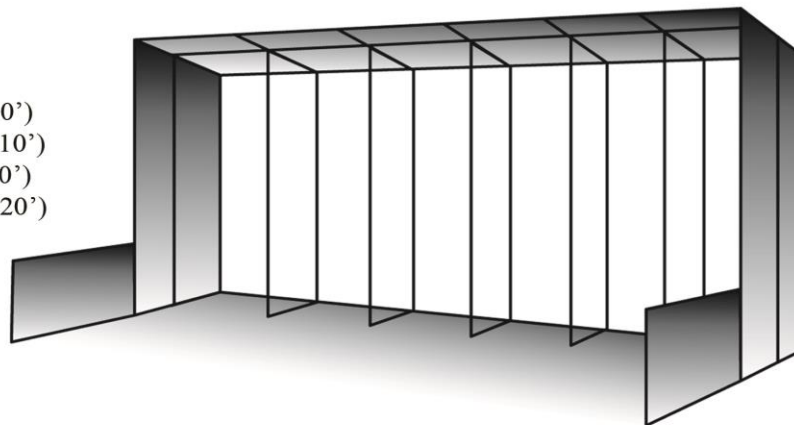

Exhibit - Option 7A (8' x 20')
Option 7B (10' x 20')

Exhibit - Option 8A (8' x 10')
Option 8B (10' x 10')
Option 8C (8' x 20')
Option 8D (10' x 20')





1600 33rd Street, Unit 102
Orlando, Florida 32839
T. 407.872.2223 F. 407.872.8644
Email: orders@gobencs.com

Rental Unit Order

Exhibiting Company:	
Booth:	

Credenza & Computer kiosk's (white panels)				
Qty	Option	Discount	Standard	Total
	1A	\$298	\$372	
	1B	\$398	\$497	
	2	\$385	\$481	
	3A	\$650	\$810	
	3B	\$975	\$1200	

Additional options available				
Qty	Option	Discount	Standard	Total
	Colored panels	\$110.00	\$137.00	
	Black			
	Gray			
	Blue			
	Lockable Doors	\$25.00	\$31.00	
	Company Logo/Graphics	Call		

Table Top & Pop Up				
Qty	Option	Discount	Standard	Total
	4	\$260	\$325	
	5	\$560	\$700	
	Black			
	Blue			

Step 1 - Custom Rental Exhibit (6 & 7)				
Qty	Option	Discount	Standard	Total
	6A	\$1600	\$2000	
	6B	\$1600	\$2000	
	7A	\$3500	\$4370	
	7B	\$3500	\$4370	

Choose your sintra panel colors	
<input type="checkbox"/>	White
<input type="checkbox"/>	Black

Step 1 - Custom Rental Exhibit (8)				
Qty	Option	Discount	Standard	Total
	8A	\$2000	\$2500	
	8B	\$2000	\$2500	
	8C	\$3850	\$4800	
	8D	\$3850	\$4800	

Choose your Plexi Glass colors	
<input type="checkbox"/>	White
<input type="checkbox"/>	Blue
<input type="checkbox"/>	Blue & White (mix)

Bring your exhibit to life with our eye catching color panels. Choose from our standard colors & Materials or you may also order designer panels - colors are available upon request.

All orders and accessories are rentals, not considered sales as they must be returned at the end of show.



**THIS FORM MUST BE ACCOMPANIED BY:
CREDIT CARD BILLING CARD AUTHORIZATION or the
THIRD PARTY CREDIT CARD BILLING FORM. ORDERS
WITHOUT PAYMENT CANNOT BE PROCESSED.**

Step 2 - Choose your Carpet Color			
<input type="checkbox"/>	Black	<input type="checkbox"/>	Burgundy
<input type="checkbox"/>	Gray	<input type="checkbox"/>	Teal
<input type="checkbox"/>	Blue	<input type="checkbox"/>	Hunter Green
<input type="checkbox"/>	Red	<input type="checkbox"/>	

Step 3 - Clearly Indicate your Header Copy	

Step 4 - Choose your Letter Coloring			
<input type="checkbox"/>	Black	<input type="checkbox"/>	Burgundy
<input type="checkbox"/>	Gray	<input type="checkbox"/>	Teal
<input type="checkbox"/>	Blue	<input type="checkbox"/>	Hunter Green
<input type="checkbox"/>	Red	<input type="checkbox"/>	Yellow

If color selection is not indicated the color will be Black.

Step 5 - Choose your Accessories				
Qty	Option	Discount	Standard	Total
	Double sided Velcro	call	call	
	Clip on Spotlights	\$35.00	\$44.00	
	Ground spot lights	\$35.00	\$44.00	
	Power Strip	\$15.00	\$19.00	
	Extension Cord	\$15.00	\$19.00	
	Additional Flat Shelf	\$30.00	\$38.00	
	Literature rack	\$100.00	\$120.00	

Special Artwork or logos will be quoted upon request. Please email samples with this order and comments below	

Custom Rental Unit (6 & 7) price Includes:

Delivery, set up and removal at the close of show.

Lights, Company header in block lettering and carpet .

Custom Rental Unit (8) includes: The above minus the header.

Remember to order the following items as desired. They are NOT included with the units. Graphics, logos, Furniture, Electrical, Floral & cleaning service.

All packages can be customized or modified, depending on your specific requirements.

Exhibit Rental Unit	
Accessories	
Sales Tax: 8.75%	
Total:	

Western Orthopaedic Association (WOA)

Exhibitor Service Kit | **Discount Price Deadline Date: **Tuesday, July 16, 2019****



1600 33rd Street, Unit 102
Orlando, Florida 32839
T. 407.872.2223 F. 407.872.8644
Email: orders@gobencs.com

Carpet & Padding

Exhibiting Company:	
Booth:	

IN- LINE BOOTH CARPET

Check One	Size	Discount	Standard	Total
<input type="checkbox"/>	08' x 10'	\$160.00	\$199.00	
<input type="checkbox"/>	8' x 20'	\$270.00	\$336.00	
<input type="checkbox"/>	8' x 30'	\$405.00	\$504.00	

<input type="checkbox"/>	Black
<input type="checkbox"/>	Gray
<input type="checkbox"/>	Blue
<input type="checkbox"/>	Red

<input type="checkbox"/>	Burgundy
<input type="checkbox"/>	Teal
<input type="checkbox"/>	Hunter Green
<input type="checkbox"/>	

Booth carpet includes tape on the front, towards the aisle.

CARPET PADDING & VISQUEEN

Padding	Booth Size		Discount		Standard	
½" Thick	X	Ft. =	Sq ft.	X	\$0.80	Or \$1.00 \$
1" Thick	X	Ft. =	Sq ft.	X	\$1.60	Or \$2.00 \$

Visqueen	Booth Size		Discount		Standard	
	X	Ft. =	Sq ft.	X	\$0.80	Or \$1.00 \$

Rates are calculated at Per Square Foot

CARPET TAPE

Lineal Ft.		Rate
X		\$1.65 \$

Most facilities require taping of the front edge of carpet for safety purposes.

ISLAND BOOTH - SPECIAL CUT CARPET

Booth Size			Discount		Standard	
X	Ft. =	Sq ft.	X	\$2.50	Or \$3.10	\$

Rates are calculated at Per Square Foot ~ Minimum of 100 square feet

DELUX CARPET

Booth Size			Discount		Standard	
X	Ft. =	Sq ft.	X	\$3.25	Or \$4.05	\$

Rates are calculated at Per Square Foot ~ Minimum of 200 square feet

When ordering please select a color below

<input type="checkbox"/>	Black	<input type="checkbox"/>	Burgundy	<input type="checkbox"/>	Blue
<input type="checkbox"/>	Red	<input type="checkbox"/>	Teal	<input type="checkbox"/>	Gray

Additional colors available upon request

No Refunds will be issued on Special Cut or Deluxe orders as these items will be cut and or ordered specifically for you.

Listed prices on carpet include delivery, installation and removal. Carpet Ordered in multiples are not guaranteed in a color match. Custom carpet orders after the deadline date are subject to availability.

**THIS FORM MUST BE ACCOMPANIED BY:
CREDIT CARD BILLING CARD AUTHORIZATION or the
THIRD PARTY CREDIT CARD BILLING FORM**

Carpet Subtotal:	
Sales Tax: 8.75%	
Carpet Total:	

Western Orthopaedic Association (WOA)

Exhibitor Service Kit | **Discount Price Deadline Date: **Tuesday, July 16, 2019****



1600 33rd Street, Unit 102
Orlando, Florida 32839
T. 407.872.2223 F. 407.872.8644
Email: orders@gobencs.com

Cleaning Services

Exhibiting Company:	
Booth:	

Please note vacuuming and emptying booths is not part of your booth space rental. If you require these services they must be ordered.

EMPTY WASTEBASKET ONLY
Wastebasket will be emptied at the end of the day

Booth Size	X	Ft. =	Sq ft.	X	Rate	X # of Days	\$
	X			X	\$0.25		\$

ONE TIME BOOTH CLEANING
Cleaning done prior to show opens

Booth Size	X	Ft. =	Sq ft.	X	Rate	\$
	X			X	\$0.32	\$

DAILY BOOTH CLEANING
Cleaning done prior to show open and each morning before show starts

Booth Size	X	Ft. =	Sq ft.	X	Rate	X # of Days	\$
	X			X	\$0.29		\$

PORTER SERVICE
Per 10' booth space
Price includes emptying wastebasket and policing exhibit area at two hour intervals during show up to a maximum of 8 hours straight time

# of 10' sections	X	Rate	X # of Days	\$
	X	\$80.00		\$

POPCORN MACHINE
If you plan to bring in a popcorn machine you must notify us in advance and acquire the necessary approval from show management and the venue. You will be charged a daily cleaning fee due to the labor involved to keep the show floor clear of popcorn.

# of Popcorn Machines	X	Rate	X # of Days	\$
	X	250.00		\$

All rental carpets are delivered clean to your booth, however during exhibitor setup should the carpet become soiled, we suggest that you order the basic cleaning services prior to show opening at its current prevailing rate. All rates are based on gross square footage of your booth with a 100 square foot minimum per day. When ordering daily cleaning, you must order for every show day.

THIS FORM MUST BE ACCOMPANIED BY:
CREDIT CARD BILLING CARD AUTHORIZATION or the
THIRD PARTY CREDIT CARD BILLING FORM

Cleaning Subtotal:	
Sales Tax: 8.75%	
Cleaning Total:	



1600 33rd Street, Unit 102
 Orlando, Florida 32839
 T. 407.872.2223 F. 407.872.8644
 Email: orders@gobencs.com

Sign & Graphics

Exhibiting Company		Booth #	
Contact Email		Phone #	

Digital Graphics:

Goben CS has the capabilities to provide you with the finest digital graphic reproduction available.

Capabilities include four-color photo-quality, high-resolution digital printing for banners, signage, exhibit graphics and more.

STANDARD SIZES

Qty	SIZE	MATERIAL	Thickness	Discount	Standard	Total
	11" x 17"	Foam Board	3/16"	\$40.00	\$50.00	
	22" x 28"	Foam board	3/16"	\$64.00	\$80.00	
	24" x 36"	Ultramount	3/16"	\$94.00	\$117.00	
	28" x 44"	Ultramount	3/16"	\$132.00	\$165.00	
		Misc Other				

Qty	DIRECTIONAL BOARDS (½" Foam board)	Size	Discount	Standard	Total
	Single sided	2' x 5'	\$138.00	\$172.00	
	Double sided	2' x 5'	\$243.00	\$243.00	
	Meter Board - Single sided	3' x 7'	\$324.00	\$405.00	
	Meter Board - Double sided	3' x 7'	\$558.00	\$697.00	
	Half Moon Feet (Foam board)		\$30.00	\$37.00	
	Spider Feet (Metal)		\$30.00	\$37.00	

Qty	HANGING BANNERS (With Grommets)	Size	Discount	Standard	Total
	Single sided Economy (one time use)	4' x 6'	\$216.00	\$270.00	
	Single Sided – Heavy duty material (Multi Use)	4' x 6'	\$280.00	\$350.00	
	Double Sided – Heavy Duty (Multi Use)	4' x 6'	\$518.00	\$647.00	
	Single sided Economy (one time use)	4' x 8'	\$288.00	\$360.00	
	Single Sided – Heavy duty material for multi use.	4' x 8'	\$374.00	\$467.00	
	Double Sided – Heavy Duty (Multi Use)	4' x 8'	\$691.00	\$863.00	

GRAPHIC FILE COMPATABILITY INFO (To be emailed)

- CMYK JPEGs - 150ppi at full size (300ppi scaled to 50% for example)
- Print ready PDF (PDF/X-1a:2001) or (High Quality Print) setting. Any bitmap images down sampled 150ppi at full size.
- Adobe Illustrator, Photoshop or InDesign up to CS5. All bitmap links, 150ppi at full size.

We can also accept some of the more common graphic format files such as .tif, jpg, .pcx, gif, etc. However, these files are bitmap images that are resolution-reliant. A low resolution doc may be fine for a web page or business card, when it is enlarged for a big sign or banner, the image suffers in that it becomes blurry or pixilated with "stair stepped" edges. When sending bitmap files for large graphics the higher the resolution the better.

If in doubt, or have any questions, please contact us at info@gobencs.com

















THIS FORM MUST BE ACCOMPANIED BY:
 CREDIT CARD BILLING CARD AUTHORIZATION or the
 THIRD PARTY CREDIT CARD BILLING FORM. ORDERS
 WITHOUT PAYMENT CANNOT BE PROCESSED.

Furnishings Subtotal:	
Sales Tax: 8.75%	
Furnishings Total:	



1600 33rd Street, Unit 102
 Orlando, Florida 32839
 T. 407.872.2223 F. 407.872.8644
 Email: orders@gobencs.com

Floral & Foliage

	A	B	C	D
Option 1				
	Boston Fern	Pothos	Ivy	Orchid
Option 2 Flowering				
	Kalanchoes	Blooming mum	Azalea	Bromeliad
Option 3 2'				
	Ficus Bush	Arboricola	Spathiphyllum	Croton
Option 4 3' - 4' 5'				
	Ficus Standard	Cat Palm	Bird of Paradise	Marginata
Option 5 6' 7' & taller Special order				
	Palm	Majesty Palm	Adonidia Double	Ficus Standard



1600 33rd Street, Unit 102
 Orlando, Florida 32839
 T. 407.872.2223 F. 407.872.8644
 Email: orders@gobencs.com

Exhibiting Company Name:	
Booth#	

DISCOUNT DEADLINE is July 16, 2019
Specialty Orders must be received by July 23rd

Order Details

Goben CS reserves the right to make substitutions if a particular item is not available at the time of show. Goben CS will select at no risk.
 All flowering plants are based upon availability.
 If you are looking for arrangements that are not listed, please give Goben Convention Services a call for pricing and availability.

FLORAL – FOILAGE – LIVE PLANTS

Option 1				
Qty	Option	Discount	Standard	Total
	A (small)	\$45.00	\$56.00	
	A (large)	\$79.00	\$98.75	
	B	\$40.00	\$50.00	
	C	\$40.00	\$50.00	
	D	\$50.00	\$62.00	

Option 5					
Qty	Option	Size	Discount	Standard	Total
	A	6'	\$135.00	\$169.00	
	B	6'	\$135.00	\$169.00	
	C	6'	\$135.00	\$169.00	
	D	6'	\$135.00	\$169.00	
	A,B,C,D	7'		(Call)	

Option 2 (Seasonal)				
Qty	Option	Discount	Standard	Total
	A	\$40.00	\$50.00	
	B	\$40.00	\$50.00	
	C	\$40.00	\$50.00	
	D	\$45.00	\$56.00	

Floral Arrangements				
Qty	Description	Discount	Standard	Total
	12" Arrangement	\$93.00	\$116.00	
	24" Arrangement	\$116.00	\$145.00	
	12" Tropical Arrangement	\$132.00	\$165.00	
	24" Tropical Arrangement	\$171.00	\$213.00	
	Custom Arrangement		(call)	

Option 3					
Qty	Option	Size	Discount	Standard	Total
	A	2'	\$47.00	\$59.00	
	B	2'	\$47.00	\$59.00	
	C	2''	\$47.00	\$59.00	
	D	2'	\$47.00	\$59.00	

Color Preference (if available)	

Option 4					
Qty	Option	Size	Discount	Standard	Total
	A	3' - 4'	\$63.00	\$79.00	
	B	3' - 4'	\$63.00	\$79.00	
	C	3' - 4'	\$63.00	\$79.00	
	D	3' - 4'	\$63.00	\$79.00	
	A	5'	\$79.00	\$99.00	
	B	5'	\$79.00	\$99.00	
	C	5'	\$79.00	\$99.00	
	D	5'	\$79.00	\$99.00	

SILK ARRANGEMENTS				
Qty	Option	Discount	Standard	Total
	Ivy	\$25.00	\$32.00	
	Floral Arrangement	\$65.00	\$82.00	
	4' Green Plant	\$48.00	\$60.00	
	6' Green Plant	\$74.00	\$93.00	
	9' Green Plant	\$135.00	\$169.00	

Charges listed include delivery to your booth and removal at the close of show.
 No credit or refunds will be issued on floral orders cancelled within 5 days of delivery.
 All ordered are rentals, not considered sales as they must be returned at the end of show.
 Note: Damaged or stolen plants are Exhibitors Responsibility, to be paid for at retail value.

**THIS FORM MUST BE ACCOMPANIED BY: CREDIT CARD BILLING CARD AUTHORIZATION or THIRD PARTY CREDIT CARD BILLING FORM.
 ORDERS WITHOUT PAYMENT CANNOT BE PROCESSED**

Services	
Subtotal:	
Sales Tax:	
8.75%	
Services	
Total:	

Western Orthopaedic Association (WOA)

Exhibitor Service Kit | **Discount Price Deadline Date: **Tuesday, July 16, 2019****



1600 33rd Street, Unit 102
 Orlando, Florida 32839
 T. 407.872.2223 F. 407.872.8644
 Email: orders@gobencs.com

Audio Visual

Exhibiting Company Name:	
Booth#	

**Please note pricing is charged on a daily rate, however max charge will be 3 days
 A wide range of items are available. If they are not listed below please call for pricing and availability.**

Monitors (Flat screen)					
Qty	Description Size	# of Days	Daily Rates		Total
			Discount	Standard	
	19" LED		\$70.00	\$87.50	
	23" LED		\$125.00	\$156.00	
	32" LED		\$250.00	\$312.00	
	42" LED		\$300.00	\$375.00	
	46" LED		\$350.00	\$438.00	
	50" LED		\$400.00	\$500.00	
	55" LED		\$450.00	\$562.00	
	60" LED		\$550.00	\$687.00	

Monitor Stands (required for 32" Monitors and up)					
Qty	Description	# of Days	Daily Rates		Total
			Discount	Standard	
	Table Stand		\$25.00	\$31.25	
	Wall Mount		\$25.00	\$31.25	
	Floor Stand		\$75.00	\$94.00	

Computers					
Qty	Description	# of Days	Daily Rates		Total
			Discount	Standard	
	Laptop Computer		\$125.00	\$156.00	
	iMac 27" Core i7		\$350.00	\$437.00	
	Software Licence		30.00	-	\$30.00

Office Equipments					
Qty	Description	# of Days	Daily Rates		Total
			Discount	Standard	
	Wireless Keyboard/mouse		\$25.00	\$32.00	
	Fax Machine		\$75.00	\$94.00	
	HP Laser Printer		\$125.00	\$156.00	
	Table Top Copier		\$125.00	\$156.00	

Projection Equipment (LCD Projectors)					
Qty	Description	# of Days	Daily Rates		Total
			Discount	Standard	
	Sanyo (3000 lumen)		\$300.00	\$375.00	
	Sanyo (5000 lumen)		\$600.00	\$750.00	
	Single mount flyware		\$30.00	\$37.00	
	Lenses available		Call		
	6' Tripod Screen		\$35.00	\$44.00	
	8' Tripod Screen		\$40.00	\$50.00	
	10' Cradle Screen		\$75.00	\$94.00	
	6' x 8' Fast Fold Screen				
	Front		\$75.00	\$94.00	
	Rear		\$85.00	\$107.00	
	Trim		\$85.00	\$106.00	

Video Players					
Qty	Description	# of Days	Daily Rates		Total
			Discount	Standard	
	DVD Player		\$40.00	\$50.00	
	DVD Blue Ray		\$80.00	\$100.00	
	DVD Multi Zone		\$125.00	\$157.00	
	Pro DVD Player		\$125.00	\$157.00	
	DVD Blu Ray Recorder		\$200.00	\$250.00	

iPad Kiosk (for iPad 2 & 3) Locks iPad securely					
Qty	Description	# of Days	Daily Rates		Total
			Discount	Standard	
	iPad Kiosk		\$120.00	\$150.00	

**Exhibitors are required to provide the necessary cables to hook up devices to TV/Monitors.
 If you request Gobencs to provide the necessary cables then you must specify the cables required.
 Standard cables are available for rent at a cost of \$10 each
 Specialty cables are also available. Gobencs must be contacted in order to confirm availability.**

Rental Procedures:

All equipment will be delivered, installed and tested.
 A service fee (delivery & pick up) equal to 20% of the equipment subtotal will be charged on all rentals. (minimum \$50)
 Cancellation fees of 25% will apply to orders cancelled within 5 days of delivery.
 All ordered furnishings and accessories are rentals, not considered sales, they must be returned at the end of show.
 Customer is responsible for contacting the electrical contractor for power requirements.

**THIS FORM MUST BE ACCOMPANIED BY:
 CREDIT CARD BILLING CARD AUTHORIZATION or the
 THIRD PARTY CREDIT CARD BILLING FORM. ORDERS
 WITHOUT PAYMENT CANNOT BE PROCESSED.**

Equipment Total	
Sales Tax 8.75% (Equipment rental only)	
Service fee 20% (Equipment total only)	
Total	



1600 33rd Street, Unit 102
Orlando, Florida 32839
T. 407.872.2223 F. 407.872.8644
Email: orders@gobencs.com

Labor & Forklift

Exhibiting Company:	
Booth:	

LABOR RATES & DETAILS

LABOR RATES	
Straight Time	\$85.00 p/p/p/h
Overtime	\$110.50 p/p/p/h
Double-Time	\$143.65 p/p/p/h

The current listed hourly rates are listed at a per person, per hour as indicated by p/p/p/h. Work will be done on a straight time basis if possible. However, overtime charges will be involved on all show floor orders. If the number of labor hours and/or workers are less than what was ordered in advance, the exhibitor will still be charged for advance order of the hours and/or workers.

LABOR RATES FOR ONSITE ORDERS

Labor orders received on-site will incur a 30% surcharge.

OVERTIME HOURS

Overtime hours are before 8:00am or after 4:30pm Monday – Friday and all day Saturday.

DOUBLE-TIME HOURS

Double-time hours are Monday- Saturday 12:00 midnight - 6:00am and all day Sunday and Holidays.

NON-USE OF ORDERED LABOR SERVICES

If an exhibitor fails to pick up labor time as ordered, a 1 (one) hour per worker no show charge will be applied to the clients invoice.

LABOR PLAN A Supervision by Goben Convention Services

Exhibits will be setup prior to exhibitor's arrival under the direction of Goben Convention Services Personnel.

The supervision charge for this service is 30% of the total labor bill, with a minimum charge of \$40.00.

LABOR PLAN B Supervision by Exhibiting Personnel

Supervisor must check in a Service Desk to pick up laborers.

Upon completion of work, supervisor must return to the service desk to release laborers.

Start time only guaranteed where labor is requested at the start of the working day, unless the official setup time is later in the day.

Workers are assigned orders and completion time of their assignments is uncertain. Therefore starting time cannot be guaranteed although every effort will be made to provide labor at requested times

Selection of Labor Plan:
(Select One)

<input type="checkbox"/>	Labor Plan A
<input type="checkbox"/>	Labor Plan B

Upon selection, fill out the details of your labor plan below

	Date	Time	# of Laborers	Hours per Laborer	Hourly Rate	Total Cost
Install						
Dismantle						
Supervision						
Total						

FORKLIFT ORDER – 5000lbs

FORKLIFT LABOR RATES	
Straight Time	\$188.00 per hour
Overtime	\$235.00 per hour
Double-Time	\$376.00 per hour

A forklift operator and crew will be assigned at the following rates per hour. If additional personnel are required to assist, you will be billed at the hourly labor rates. Forklift crews do not need to be ordered if this is part of the material handling process. Orders received after the discount date will incur a 20% surcharge. Order received on-site will incur a 30% surcharge.

	Date	Time	Additional Laborers	Hours Per Laborer	Hourly Rate	Total Cost
Install						
Dismantle						

THIS FORM MUST BE ACCOMPANIED BY:
CREDIT CARD BILLING CARD AUTHORIZATION or the
THIRD PARTY CREDIT CARD BILLING FORM. ORDERS
WITHOUT PAYMENT CANNOT BE PROCESSED.

Services Total:	
-----------------	--



1600 33rd Street, Unit 102
Orlando, Florida 32839
T. 407.872.2223 F. 407.872.8644
Email: orders@gobencs.com

Material Handling Information

EXCLUSIVE Material Handling Contractor

Goben Convention Services are under contract with WOA. We will handle ALL freight/exhibit material in and out of the ballroom. For your convenience labels are provided in this exhibitor manual. You must return in advance of the show the Method of payment form, along with the completed Material handling service & rates form.

Advance Freight Shipments (Ship as early as possible)

You get 30 days storage included with Material Handling fees!
Warehouse receiving hours are 8:30am – 4:00 pm, Monday – Friday. Shipments can begin arriving June 24th and should arrive no later than July 26th. Shipments that arrive at the advance warehouse after July 19th will be charged a late fee of 25% of the material handling fee. Please ship to the advance warehouse and you will only be charged one-time. It is much less expensive to ship to the advance warehouse and be charged a one-time material handling fee than to send to the hotel and be charged twice for the same service.

Direct to Show Site Shipments

Do not ship freight to the show-site prior to the move in day!
Freight shipped to the venue before the move in day will either be **REFUSED** or you will be charged a handling & storage fees from the hotel. The freight will then be turned over to Goben CS for delivery to the exhibit hall and you will **ALSO** be charged material handling fees, **even if you are a guest of the hotel.**
Please note: Mislabeled packages have the potential of being refused at show site. Please remember to include WOA c/o Goben CS on all packages AND remove all old labels from packaging.

Overtime +25% (inbound and/or outbound)

A overtime surcharge, per cwt, for each occurrence will apply if:
-Shipments are received on overtime (Monday-Friday, before 8:00am and after 4:30pm and **ALL DAY Saturday, Sunday and Holidays**).
-A surcharge applies if your shipment is moved to or out of show site on overtime due to scheduling beyond Goben CS control.
-A surcharge will apply if your advanced shipment is received at the warehouse on straight-time, but had to be delivered to show site on overtime due to a scheduling beyond the control of Goben CS.

Special Handling +30% (inbound and/or outbound)

A special handling surcharge, per cwt, for each occurrence will apply if:
-Uncrated shipments that must be taken off pallets and hand carried in loose will be charged an additional 30%.
-Van Lines, loose, uncrated or improperly packaged materials, or those delivered by a carrier not providing supporting paperwork will be charged an additional 30%.
- Items that are too large to fit through ballroom doors and must be uncrated in hallway or loading dock
- Goben CS will not be held responsible for the dimensions of the hotel dock doors, freight elevator or the ballroom doors.

UPS, Fed Ex, DHL etc Shipments

Shipments delivered via small package carriers require additional time & Labor to unload, sort & deliver, therefore a special handling fee of 25% will be added to the material handling rate.
The above freight carriers DO NOT provide bills of lading to note any damage or piece count. Therefore, Goben CS will NOT be responsible and will not accept any claims for any reason involving carriers that do not use bills of lading.

Outbound Instructions at close of show

It is the exhibitor's responsibility to arrange outbound shipments with their designated carrier (If other than UPS Freight). Schedule your carrier to pick up your freight, directly from the exhibit hall, no later than the reroute time. (Reroute time is 12:31pm on August 3rd)

*If an exhibitor is shipping out via UPS or Fed Ex and they fail to pick up or the facility does not allow us to turn the items over for their daily pick up, then your items will be taken back to Goben's warehouse to ship out if room allows on our truck. Fees will be apply and will be added to the final invoice. (Also applies to common carriers)

At the close of the show, each exhibitor must fill out a **Bill of Lading and hand in to the on-site service desk**. Outbound shipping forms will be available at the service desk. Should the exhibitor fail to provide outbound shipping paperwork and it is not turned into the service desk, a labor charge will be added to the exhibitor's final invoice.

Any shipment left in a booth for which no disposition is provided, or if requested carrier fails to pick up or refuses to take shipment, Goben Convention Services reserves the right to re-route shipment using UPS Freight or return material to our warehouse at the exhibitor's expense. For more information, please see the Move Out information sheet enclosed in this manual.

Material Handling - Does NOT Include

- Labor and/or equipment for uncrating, un-skidding, assembling, dismantling, re-crating and re-skidding. These services may be ordered by filling out the labor forms included in this manual.
- Scheduling any carrier for pick up or delivery of your materials, if other than the official show carrier (UPS Freight).
- As an exhibitor it is your responsibility for providing your carrier with the proper delivery and pick up information.

Material Handling - DOES Include

- Receiving and unloading your shipment at our warehouse (30 days free storage prior to show date).
- Reloading on the Goben Convention Services trailer.
- Delivery of shipment to the exhibit hall
- Placement of shipment in your booth space
- Removal of empty containers
- Return of empty containers at close of show (All containers must be empty when stored, Goben Convention Services assumes no liability for material or equipment left inside a container marked as empty).
- Removal of all packed and labeled materials from the exhibit booth.
- Reloading on to an outbound carrier for return shipment (based on shipping information provided on your show Bill of Lading).

Charges for the above services will be based on the inbound weight only (each shipment is evaluated separately), whether the above services are used completely or in part. Refer to the material handling services and rates for detailed pricing information.

Weight taken from inbound bill of lading is rounded up to the next hundred pounds. Goben Convention Services will assign a weight to shipments arriving without a bill of lading of certified weight tickets. Shipments received without weight tickets will be charged an additional 30%.

Research + 30%

If exhibitor name, show name etc is not visible on the shipping label, a research rate will apply in addition to your material handling rate.



1600 33rd Street, Unit 102
Orlando, Florida 32839
T. 407.872.2223 F. 407.872.8644
Email: orders@gobencs.com

Material Handling Information (con't)

Money Saving Tips

Consolidate shipments when total weight is less than 200lbs.
3 Separate Shipments **1 Consolidated Shipment**
65lbs charged @ 200lbs \$196.00 3 pieces (1 shipment)
89lbs charged @ 200lbs \$196.00 196lbs @ 200lbs = \$196.00
42lbs charged @ 200lbs \$196.00 **Total Savings: \$392.00**
Total 196lbs Total cost \$588.00

Additional charges may be applicable to the CWT rates

Recommended Inbound & Outbound Freight Carrier

UPS Freight is the preferred show carrier. If you use UPS Freight you do not need to worry about scheduling freight carriers, waiting charges or forced freight shipments.



CONVENIENT 24 HOUR TRACKING

800.988.9889
www.UPSFreight.com

UPS FORM LOCATED AT THE BACK OF THIS MANUAL
MENTION SHOW NAME FOR DISCOUNTED SHOW RATES

Misc Material Handling Information

- Goben Convention Services will not be responsible for piece count or condition of shipments that are delivered without supporting bill of lading or delivery slip.
- Remember that all shipments must be PREPAID, DO NOT SHIP "COLLECT". All shipments sent "COLLECT" WILL BE REFUSED.
- You may confirm receipt of your shipment by calling Gobencs 407.872.2223
- Exhibitors can hand carry their own materials into the exhibit hall, provided they use their personal vehicle and company employees to do so. Freight being delivered to the loading dock in vehicle other than personal must be unloaded and delivered by Gobencs.
- Due to insurance purposes.....No material handling equipment such as dollies or pallet jacks shall be used by anyone other than Gobencs.
- Shrink wrap and banding will incur a one ½ hour labor charge.

Accessible Storage

Storage of equipment that requires access will be quoted on-site.

Empty Container Storage

Storage of empty containers is included with your material handling service. Empty containers must be labeled with an "empty" sticker. Before the show opens, all trash will be removed from the aisles, Gobencs is NOT responsible for containers nor packaging materials that are not properly labeled with "empty" stickers. Stickers are available at the service desk.
If you brought your own materials in and wish to have Gobencs store your empty containers, there will be a charge of \$25 per item or \$0.25c per lb whichever is greater

Disposable Crate Charge

Leftover empty crates that need to be disposed of will incur a labor fee. Labor fee will be quoted on-site.

Return to Gobencs Warehouse

If you wish to have your freight returned to Gobencs Warehouse, prior arrangements must be made with our office staff. Please note that Gobencs warehouse address may NOT be the same as the advanced shipping address.

Short Term / Long Term Storage Options

Storage facilities are available for short and long term, please call for a quote if there is interest for this service.

Insurance

It is understood that Gobencs is not an insurer that insurance, if any, should be obtained by the exhibitor. Exhibitors are recommended to carry All-Risk Insurance covering your materials against damage, loss and all other hazards from the time of shipping to returning from show. This can usually be done by adding "riders" to existing policies.

Limitation of Liability & Responsibility

Gobencs shall not be responsible for damage to uncrated materials; materials improperly packed or concealed damage.

Gobencs shall not be responsible for loss, theft or disappearance of exhibitor's materials after same has been delivered to exhibitor's booth.

Gobencs shall not be responsible for loss, theft or disappearance of materials before they are picked up from exhibitor's booth for reloading after the show. Bills Of Lading covering outgoing shipment, which are furnished by Gobencs to exhibitors will be checked at time of actual pick up from the booth and corrections are made where discrepancies occur.

Gobencs shall not be responsible for loss, damage or delay due to fire, Acts of God, strikes, lockouts or work stoppages made where discrepancies occur.

Gobencs Liability shall be limited to the physical loss of or damage to specific article which is lost or damaged, and in any event Gobencs maximum liability shall be limited to \$0.30 per pound per article with a maximum liability of \$50.00 per item, or \$1,000.00 per shipment, whichever is less.

Claims for loss or damage must be submitted to Gobencs prior to the close of show. No suit or action shall be brought against Gobencs more than one year after the accrual of the cause of action.

The consignment or delivery of a shipment to Gobencs by an exhibitor, or by any shipper to or on behalf of the exhibitor, shall be construed as an acceptance by such exhibitor (and/or other shipper) of the terms and conditions set forth.

Empty container labels will be available at the Gobencs Desk. Affixing the labels is the sole responsibility of the exhibitor or his/her representative. All previous labels should be removed or obliterated. Gobencs assumes no responsibility for:

- Error to above procedures
- Removal of Containers with old empty labels and without Gobencs Labels.
- Improper Information on Empty Labels
- Materials stored in container with empty labels.



1600 33rd Street, Unit 102
Orlando, Florida 32839
T. 407.872.2223 F. 407.872.8644
Email: orders@gobencs.com

Material Handling Service & Rates

Exhibiting Company:	
Booth:	

ADVANCE WAREHOUSE ADDRESS
<p>Show Ready c/o Goben Convention Services 224 Mercury Circle Pomona, CA 91768</p>
<p>Must be received by July 26th In Observance of Independence Day July 4-5, 2019 – Closed All Day</p>

IMPORTANT MATERIAL HANDLING DATES	
	Mark your Calendar
Shipments can start arriving at Advance Warehouse	June 24, 2019
In Observance of Independence Day	July 4-5, 2019 Closed All Day
Last Day for Shipment to arrive at warehouse w/o surcharge	July 19, 2019
Last day for shipments to arrive at warehouse	July 26, 2019 STRICTLY ENFORCED!
Shipments can start arriving at Show Site	July 31, 2019 STRICTLY ENFORCED!

FREIGHT RATES

Rates below include receipt of your freight, delivery to your booth, removal, storage, return empty crates and at the end of the show movement of your freight from the booth to the loading dock and reloading onto the designated truck. Charges for this service will be based on the inbound rate and rounded up to the nearest one hundred weight. A 200lbs minimum per shipment applies. (____ pounds ÷ 100 = ____ Total CWT)

Overtime: In addition to your plan below please fill out plan C if your shipment is moved in and/or out of show site on overtime. (Monday-Friday, before 8:00am and/or after 4:30pm, ALL DAY Saturday, Sunday and Holidays).

PLAN	DESCRIPTION		RECEIVED AT	RATE PER CWT
A	Package Shipments Received	June 24 – July 26	Warehouse	\$98.00
A+B	Late Shipment Surcharge	After July 19	Warehouse	Additional 25%
C	Overtime in and/or out		WH / SS	Additional 25%
D	Special Handling (UPS, Fed-Ex, DHL etc)		WH / SS	Additional 25%
E	Special Handling (see material handling information)		WH / SS	Additional 30%
F	Package Shipments	Scheduled to arrive on July 31st	Show Site	\$98.00
G	Small Package Shipment	Total Shipment of 25lbs	Show Site	\$50.00
H	Returned to Warehouse	Prior Arrangements must be made		Call for pricing
I	Shrink Wrap + one ½ hour Labor Charge		Per Skid	\$25.00 plus labor
J	Banding + one ½ hour Labor Charge		Per Linear Foot	\$1.25 plus labor
K	Shipments delivered before scheduled dates		WH / SS	Additional 25%
L	Misc.			

FREIGHT PAYMENT COMPUTATION – Please include if applicable the surcharges i.e. late, overtime in/and or out, special handling

	SELECT PLANS (A-J)	# OF PIECES	WEIGHT MIN 200lbs	RATE/CWT	TOTAL
Shipment 1					
Shipment 2					
Shipment 3					

**Please take note of
ORDER DEADLINE FOR MATERIAL
HANDLING/SHIPMENTS LISTED ON THIS
FORM.**

THIS FORM MUST BE ACCOMPANIED BY:
CREDIT CARD BILLING CARD AUTHORIZATION or the
THIRD PARTY CREDIT CARD BILLING FORM. ORDERS
WITHOUT PAYMENT CANNOT BE PROCESSED.
SUBMITTAL OF ORDER AFFIRMS THAT YOU UNDERSTAND
THE TERMS & CONDITIONS LISTED ON THE MATERIAL
HANDLING SECTION OF THE EXHIBITOR KIT.

Services Subtotal:	
Misc	
Services Total:	



1600 33rd Street, Unit 102
 Orlando, Florida 32839
 T. 407.872.2223 F. 407.872.8644
 Email: orders@gobencs.com

Exhibitor Shipping Information

Exhibiting Company:	
Booth:	

The following information is requested so that we may plan in advance and arrange for the proper equipment needed to offer the best possible service to you. We understand that your calculation is only an estimate. Invoicing will be done from the actual weight. Adjustments will be made accordingly.

SHIPMENTS WILL BE SENT TO: ADVANCE WAREHOUSE SHOW SITE

INCOMING SHIPMENT

Shipped from (city)			
Carrier		Tracking/Pro #	
Shipping date		Expected arrival date	
No. of Pieces		Estimated weight	
Dimensions of largest piece	Height:	Width:	Length:
Misc Requirements			

ADDITIONAL INCOMING SHIPMENT (Different location)

Shipped from (city)			
Carrier		Tracking/Pro #	
Shipping date		Expected arrival date	
No. of Pieces		Estimated weight	
Dimensions of largest piece	Height:	Width:	Length:
Misc Requirements			

OUTGOING SHIPMENTS

The below information is for back up should the on-site exhibitor fail to complete and turn in a bill of lading to Goben CS Personal.
 Should the exhibitor change the address below or the address is incorrect, Goben CS will not be held responsible.

INSTRUCTIONS FOR OUTGOING SHIPMENTS

Ship To (Company)		<input type="checkbox"/> Prepaid	<input type="checkbox"/> Collect
Attention			
Address			
City/State/Zip			
Description			
No. of pieces		Total Weight	
Outbound Carrier		Pro #:	

Western Orthopaedic Association (WOA)

Exhibitor Service Kit | **Discount Price Deadline Date: **Tuesday, July 16, 2019****

- ADVANCED WAREHOUSE SHIPPING LABEL -

ADVANCE WAREHOUSE			
EXHIBITION MATERIAL FROM	TO EXHIBITING COMPANY NAME		
BOOTH #	SHOW NAME		
	WOA		
 Show Ready c/o Goben Convention Services 224 Mercury Circle Pomona, CA 91768			
Number		OF	PIECES
CARRIER			
*			

MAKE COPIES AND CUT AS NECESSARY - MAKE COPIES AND CUT AS NECESSARY - MAKE COPIES AND CUT AS NECESSARY

ADVANCE WAREHOUSE			
EXHIBITION MATERIAL FROM	TO EXHIBITING COMPANY NAME		
BOOTH #	SHOW NAME		
	WOA		
 Show Ready c/o Goben Convention Services 224 Mercury Circle Pomona, CA 91768			
Number		OF	PIECES
CARRIER			
*			

- SHOW SITE SHIPPING LABEL -

SHOW SITE DELIVERY				
EXHIBITION MATERIAL FROM		TO EXHIBITING COMPANY NAME		
BOOTH #		SHOW NAME		
		WOA		
 The Hyatt Regency C/O Goben Convention Services 1 Old Golf Course Rd Monterey, CA 93940				
Number		OF		PIECES
CARRIER				
*				

SHOW SITE DELIVERY				
EXHIBITION MATERIAL FROM		TO EXHIBITING COMPANY NAME		
BOOTH #		SHOW NAME		
		WOA		
 The Hyatt Regency C/O Goben Convention Services 1 Old Golf Course Rd Monterey, CA 93940				
Number		OF		PIECES
CARRIER				
*				

MAKE COPIES AND CUT AS NECESSARY - MAKE COPIES AND CUT AS NECESSARY - MAKE COPIES AND CUT AS NECESSARY

SHOW SITE DELIVERY				
EXHIBITION MATERIAL FROM		TO EXHIBITING COMPANY NAME		
BOOTH #		SHOW NAME		
		WOA		
 The Hyatt Regency C/O Goben Convention Services 1 Old Golf Course Rd Monterey, CA 93940				
Number		OF		PIECES
CARRIER				
*				

SHOW SITE DELIVERY				
EXHIBITION MATERIAL FROM		TO EXHIBITING COMPANY NAME		
BOOTH #		SHOW NAME		
		WOA		
 The Hyatt Regency C/O Goben Convention Services 1 Old Golf Course Rd Monterey, CA 93940				
Number		OF		PIECES
CARRIER				
*				



1600 33rd Street, Unit 102
Orlando, Florida 32839
T. 407.872.2223 F. 407.872.8644
Email: orders@gobencs.com

Move Out Information

On behalf of Goblen Convention Services we would like to thank you for letting us assist you during the show. We hope the following information will help assist and expedite your move-out.

EXHIBITOR MOVE-OUT START TIME and CLEAN/CLEAR TIME

Move Out Start Date	Move Out Start Time
August 3, 2019	11am

ALL EXHIBITORS MUST BE OFF THE FLOOR BY

1pm	
August 3, 2019	

NO EXCEPTIONS

Beginning the move out time, exhibitors may begin to dismantle their booths. All empty containers will automatically be returned to booths. Please keep all aisles clear to enable Goblen Convention Services to complete this process in an expeditious manner. If you have ordered labor to dismantle your booth, be sure to confirm the start time of your works by checking in with the Goblen Convention Services; Service Desk.

DRIVER CHECK-IN & BILLS OF LADING DEADLINES

Driver Check In Date	Driver Check In Time
August 3, 2019	12:30pm

	Re-Route Time
August 3, 2019	12:31pm

BILLS OF LADING DUE TO GOBLEN CONVENTION SERVICES DESK BY

1pm	
August 3, 2019	

It is the exhibitor's responsibility to arrange outbound shipments with their designated carrier (If other than UPS Freight).

Schedule your carrier to pick up your freight, directly from the exhibit hall. Your freight carrier **MUST** be checked in at the Goblen Convention Services freight dock no later than the driver check in time and bills of lading deadlines listed on this sheet and in the exhibitor manual to guarantee pick-up. In the event that your designated carrier fails to check in, pick up, refuses acceptance or freight disposition is not provided, Goblen Convention Services reserves the right to force/re-route such shipments. Exhibitors will be charged accordingly for this service. No liability will be assumed by show management, Goblen Convention Services or any subcontractors as a result of such re-routing or handling.

A bill of lading must accompany ALL outbound shipments. Exhibit personnel **MUST** prepare the outbound bill of lading & make sure each piece of freight is labeled with the destination address prior to departing the show. This form may be obtained at the Goblen Convention Services Service Desk. All bills of lading must be turned into the services desk when all your shipments are packed, labeled and ready to ship. Failure to complete and turn in a bill of lading will result in a half hour labor charge.



UPS Freight is the designated show carrier and a representative will be located at the Goblen CS Service Desk.

Goben CS will not be responsible for literature/product not properly packed and labeled by exhibit personnel.

DO NOT LEAVE BILLS OF LADING IN YOUR BOOTH!



Trade show shipping made easier for you.



Your booth is the centerpiece of your company's trade show presence. If it doesn't arrive intact and on time, your business could miss out on a golden opportunity to gain exposure within the industry.

At UPS Freight®, we understand your trade show needs, and we're here to make your trade show shipping experience easier than ever.

Whether your booth is headed for the advanced warehouse or direct to the show site, the UPS Freight Trade Show Services Team can provide you with dependable transit times at the right price — ensuring that your trade show experience goes off without a hitch.

UPS Freight® Trade Show Services Team

UPS Freight has established special inbound and outbound rates to and from trade show sites on these services:

- LTL (less-than-truckload) freight shipping
- Truckload shipping
- Expedited shipping
- Specialized carriers (flatbeds, pad-wrapped, air freight, air-ride)

Contact us

Ready to take the next step?
Contact us today by phone at **800.988.9889** or via email at **upsfreighttradeshow@ups.com** to get started!



UPS Freight® Trade Show Services

Outbound Shipping

UPS Freight, the official trade show carrier, is providing the following outbound shipping service. If you have any questions or need assistance, please call our Trade Show Services Team at 1 (800) 988-9889 today!

Don't wait! Complete this form and bring it back to the UPS Freight representative at the service desk **the day before** the show closes!

Instructions

1. Prior to the end of the show, pick up a Bill of Lading form, shipping labels and Small Shipment Description form from the exhibitor service desk. Shipments going to multiple destinations require a separate Bill of Lading for each shipment.
2. While at the trade show, see the UPS Freight representative to make arrangements to use the Fast Track shipping process available by using the Official Show Carrier.
3. At the close of the show, apply shipping labels to each piece and leave all freight pieces in your booth area.
4. Complete the Bill of Lading, particularly the "Address" portion and all shaded fields. Note UPS Freight as your carrier and indicate the delivery date needed.
5. After completing the Bill of Lading, return it to the exhibitor service desk before departing from show site.

Outbound Shipping Service Form

The following services are available. Please check the appropriate box.

Truck/Ground Service: 2-5 day service

Air Freight/Expedited Service: Guaranteed service for time-critical shipments.

Order information

Booth #: Company Name: Card Type (circle one): AmEx Visa MasterCard

*For your convenience, we will use this authorization to charge your credit card account for shipping and any additional charges that may occur in handling your shipment as required by your Trade Show Representative. I certify that I have read and agree with the above statement. Initial here:

Cardholder Name: Cardholder Phone:

Credit Card Number: Expiration Date: CVV:

Credit Card Billing Address:

City: State: Zip Code:

Signature:

* By signing above, you agree to the terms and conditions as described on this payment form.

For UPS Freight use only:

PRO# for this shipment: _____ Date of PRO: ___/___/___

Name of Show: _____ Authorized Signature: _____

Charge Amount: _____ Date of Transaction: ___/___/___



EXHIBITOR COMPUTER & AUDIO/VIDEO EQUIPMENT ORDER FORM

ORDERING PRICES: To order audio/visual equipment for your booth, please fax this form to (831)657-6694 or email to pbench@psav.com or dgiuriato@psav.com
PRICES: Listed rates are for the entire run of expo. Labor is a one time charge unless otherwise specified.
 On-site cancellations will be charged at a rate of 50% of the rental amount.
DELIVERY: Equipment will be delivered at the time specified unless fork-lifts are still on the exhibit floor.
 We strongly recommend installation to be as late as possible during move-in.
ON-SITE REQUESTS: All requests placed within 72 hours of the delivery date, will be processed at the "on-site" rate.

(Equipment with * may not be readily available on-site and may only be requested ahead of time, due to basic inventory availability.)

Exhibitor Information	On-Site Information
Firm Name: _____	Show Name: _____ Email: _____
Address: _____	Room Name: _____ Booth: _____
City: _____ State: _____ Zip: _____	Delivery Date: _____ Time: _____
Ordered by: _____ Phone: _____	Opening Date: _____ Time: _____
Email: _____	Removal Date: _____ Time: _____

	DESCRIPTION	QTY	SHOW RATE	ON SITE
	POWER			
	600 Watts (5 amps)		\$ 125.00	\$ 187.50
	1200 Watts (10 amps)		\$ 185.00	\$ 277.50
	1800 Watts (15 amps)		\$ 215.00	\$ 322.50
	2400 Watts (20 amps)		\$ 240.00	\$ 360.00
	INTERNET & WI-FI			
	Wi-Fi 3mb Connection		\$ 45.00	\$ 67.50
	Wired Hardline Internet 5mb		\$ 140.00	\$ 210.00

PLEASE CALL FOR PRICING ON EQUIPMENT NOT LISTED

PAYMENT INFORMATION		Equipment Subtotal	
<input type="checkbox"/> Check Payable to: PSAV <input type="checkbox"/> Bill to Master	<input type="checkbox"/> Credit Card (in person or by phone)	If Requested On-Site (Circle One) NO YES	\$ -
		8.75% Sales Tax + Tax on Service Charge	\$ -
		Subtotal	\$ -
		Service Charge @23%	\$ -
		TOTAL AMOUNT DUE	\$ -

Requester Name _____ Billing Address _____ City _____ State _____ Zip _____ Phone Number _____ Authorized Signature _____	Please note, this form will automatically calculate the costs, based on the quantity of the items specified. Thank you.
---------------------------------------------------------------------------------------------------------------------------------------	-------------------------------------------------------------------------------------------------------------------------

5/10/2019

